

10-inch Digital VTH User's Manual

V1.0.0

Table of Contents

1	General Introduction	5
1.1	Product Intro	5
1.2	Applicable Model.....	5
2	Structure and Appearance	6
2.1	Front Panel	6
2.2	Rear Panel.....	7
3	Networking.....	9
4	Installation and Debug	10
4.1	Device Wiring.....	10
4.2	Device Installation.....	10
4.2.1	Screw	11
4.2.2	Steps.....	11
4.3	Device Debug	12
4.3.1	Before Debugging.....	12
4.3.2	Debug Device	12
4.3.3	Successfully Debug	15
5	Product Function.....	18
5.1	Homepage	18
5.2	Setting	19
5.2.1	Ring.....	19
5.2.2	DND	20
5.2.3	Alarm.....	22
5.2.4	Mode	23
5.2.5	General	23
5.2.6	Production	25
5.3	Call	26
5.3.1	Call Resident.....	26
5.3.2	Contact.....	28
5.3.3	Recent Call.....	29
5.4	SOS Call.....	30

5.5 Monitor.....	30
5.5.1 Door	30
5.5.2 IPC	32
5.5.3 Favorite	35
5.6 Arm/Disarm.....	35
5.7 Info.....	37
5.8 Default	38
Appendix 1 Technical Specification	39

Important Safeguards and Warnings

Please read the following safeguards and warnings carefully before using the product in order to avoid damages and losses.

Note:

- Do not expose the device to lampblack, steam or dust. Otherwise it may cause fire or electric shock.
- Do not install the device at position exposed to sunlight or in high temperature. Temperature rise in device may cause fire.
- Do not expose the device to humid environment. Otherwise it may cause fire.
- The device must be installed on solid and flat surface in order to guarantee safety under load and earthquake. Otherwise, it may cause device to fall off or turnover.
- Do not place the device on carpet or quilt.
- Do not block air vent of the device or ventilation around the device. Otherwise, temperature in device will rise and may cause fire.
- Do not place any object on the device.
- Do not disassemble the device without professional instruction.

Warning:

- Please use battery properly to avoid fire, explosion and other dangers.
- Please replace used battery with battery of the same type.
- Do not use power line other than the one specified. Please use it properly. Otherwise, it may cause fire or electric shock.

Special Announcement

- This manual is for reference only.
- All the designs and software here are subject to change without prior written notice.
- All trademarks and registered trademarks are the properties of their respective owners.
- If there is any uncertainty or controversy, please refer to the final explanation of us.
- Please visit our website for more information.

1 General Introduction

1.1 Product Intro

7 inch digital VTH requires simple operation and easy installation, support:

- WI-FI connection.
- Call, video talk, remote unlock with VTO.
- Message with video for call from VTO
- VTH monitors VTO or any other specific camera.
- One-click call management center (MGT center).
- Link alarm control.
- Search of all call records.

1.2 Applicable Model

This user's manual is applicable to many models of product, please refer to Chart 1-1.

Model	Color	Front Camera	Screen	SD Card
VTH5221DW	Silver+White	Not support	Capacitive touch screen	Support
VTH5221D	Gold+Black	Not support	Capacitive touch screen	Support
VTH5221DW-C	Silver+White	Support	Capacitive touch screen	Support
VTH5221D-C	Gold+Black	Support	Capacitive touch screen	Support
VTH5241DW	Silver+White	Support	Capacitive touch screen	Support

Chart 1-1

2 Structure and Appearance

2.1 Front Panel

Note:

Only VTH5221D(W)-C has front camera and other models do not support front camera. Front panel is in Figure 2-1. Components are defined in Chart 2-1.

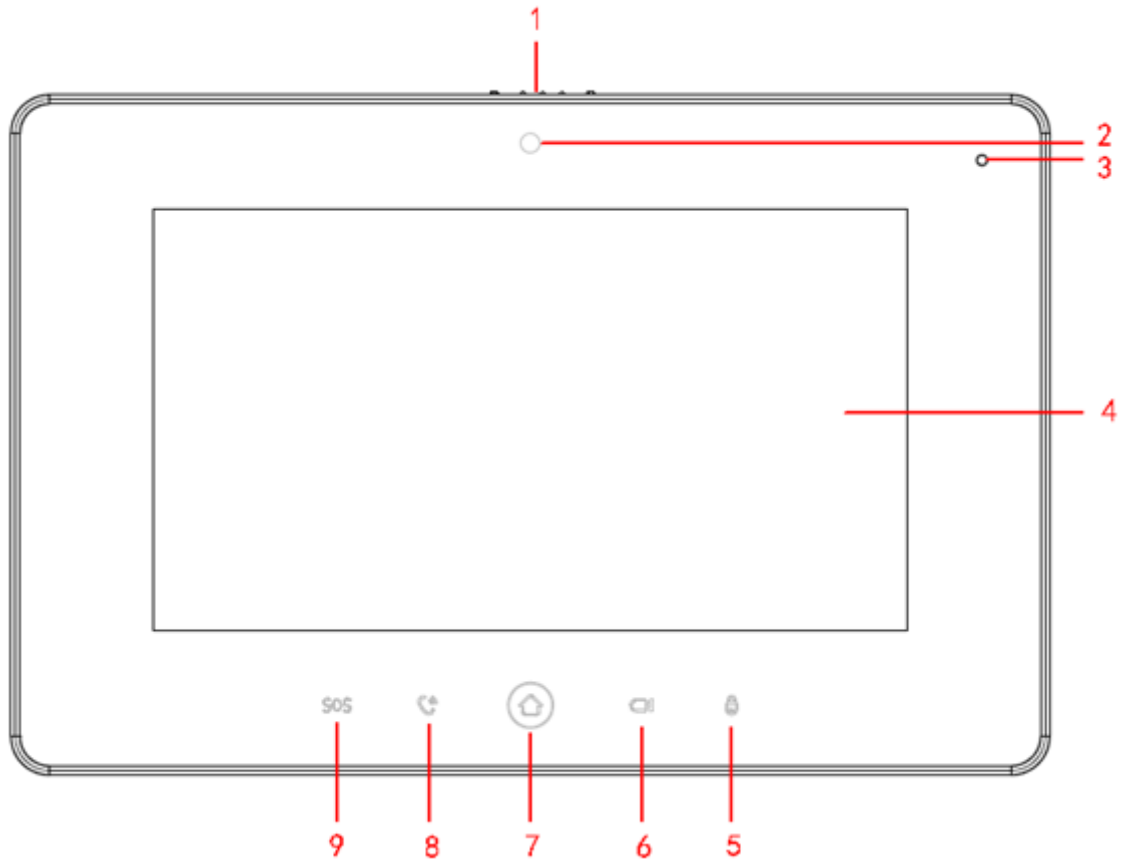

Figure 2-1

No.	Component Name	Description
1	Camera Cover Switch	Slide, you can cover or open camera.
2	Camera	-
3	MIC	-
4	Screen	-
5	Unlock	During incoming call, call, and monitoring, press this button to unlock corresponding door.
6	Monitor	Monitor VTO video.
7	Homepage	Press this button to return to homepage.
8	Call	In call status, press this button to accept call; during call, press this button to hang up.

No.	Component Name	Description
9	Emergency	In emergency, press this button to call MGT center.

Chart 2-1

2.2 Rear Panel

Different models have different rear panels, but all of interfaces are the same. Rear panel is in Figure 2-2. Components are in

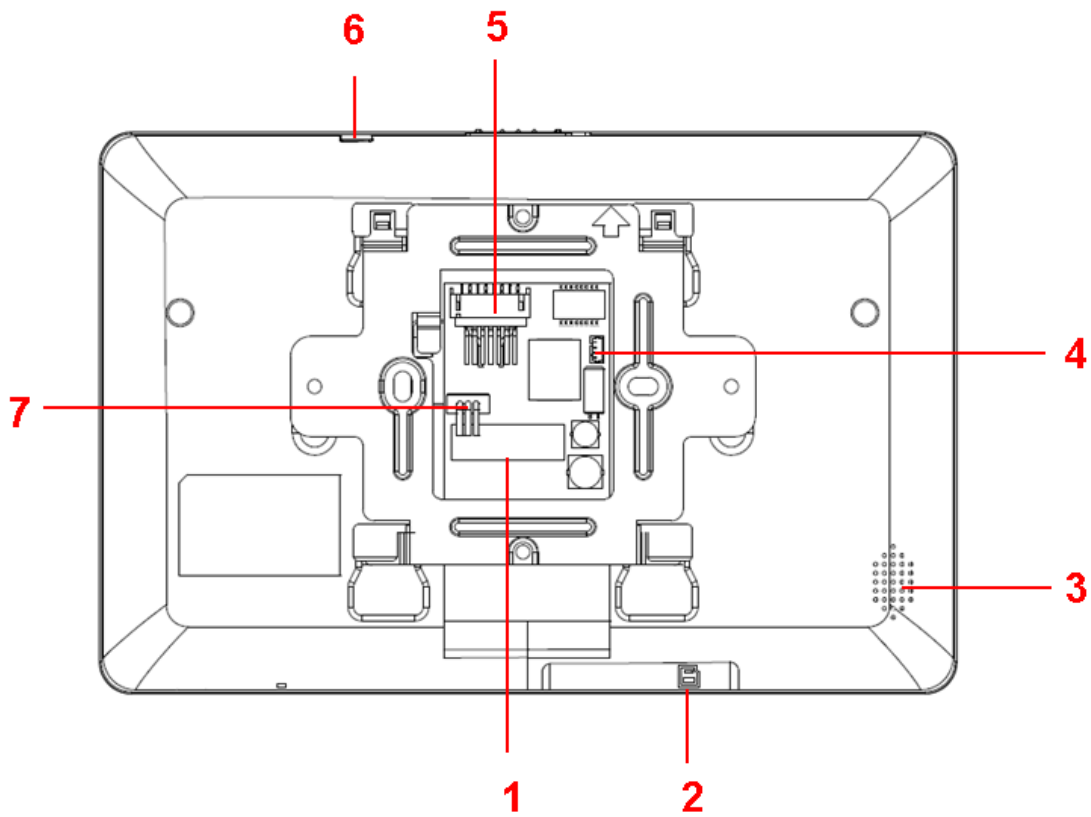

Figure 2-2

No.	Name	Description
1	Alarm Interface	6-ch alarm and 1-ch alarm output
2	SD Card Slot	Insert SD card.
3	Loudspeaker	-
4	Debug Interface	Debug serial.
5	Ethernet Port	Plug in Ethernet cable.
6	Reset	Press Reset button, to reboot system.
7	RS485	485 expansion interface.

No.	Name	Description
	Interface	

Chart 2-2

3 Networking

VTH networking is in Figure 3-1.

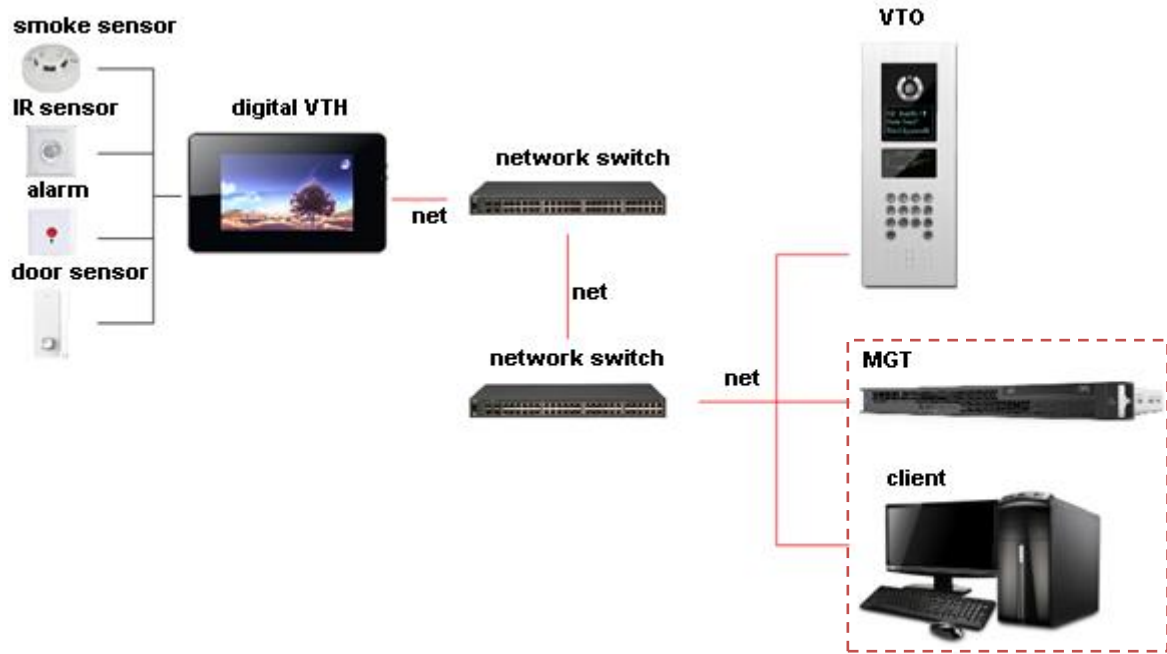

Figure 3-1

4 Installation and Debug

4.1 Device Wiring

Device wiring is in Figure 4-1.

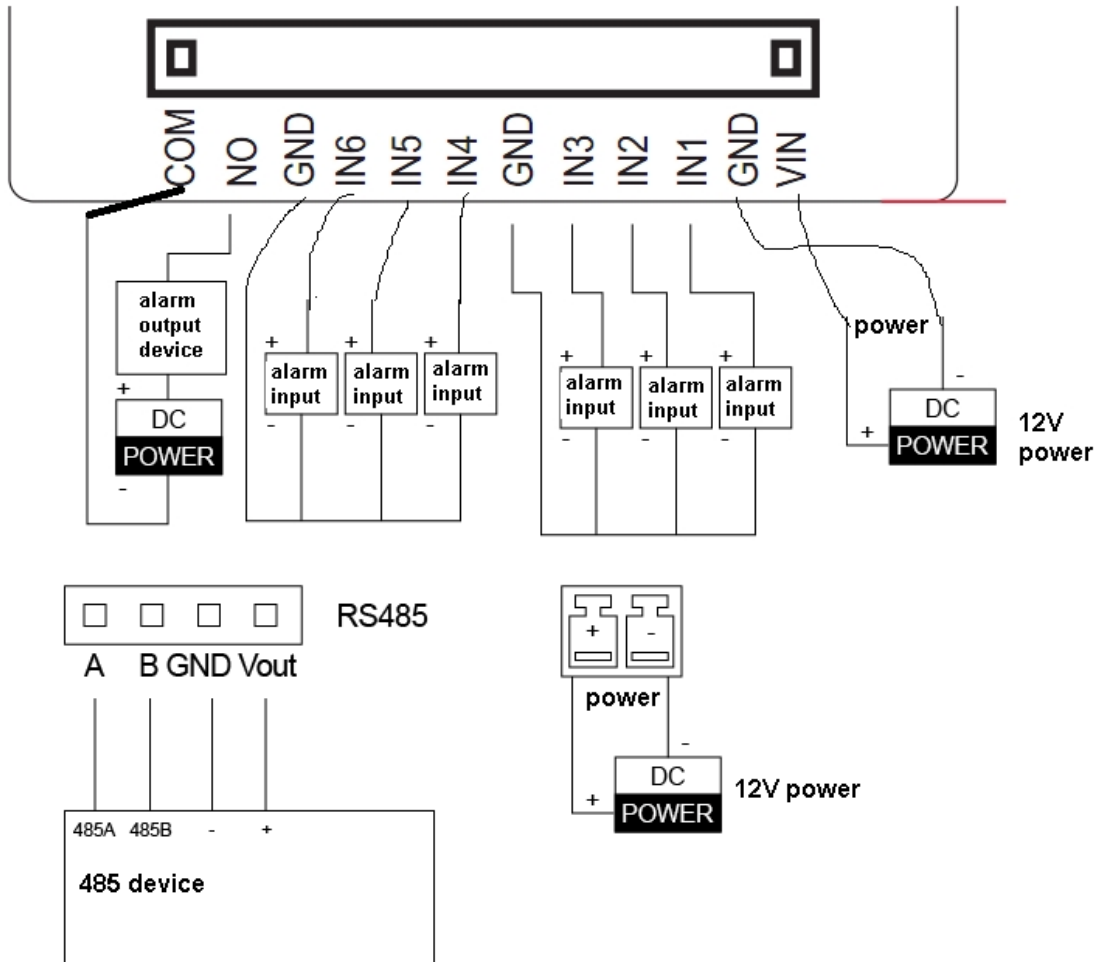

Figure 4-1

4.2 Device Installation

Warning:

- Avoid installation in poor environment, such as condensation, high temperature, oil stain, dust, corrosion or direct sunlight.
- Project installation and debugging must be done by professionals. Please do not open the

device in case of failure, and please contact after sales service.

4.2.1 Screw

Component Name	Diagram	Quantity
M4×30 cross pan head machine screw		2

Chart 4-1

4.2.2 Steps

See Figure 4-2.

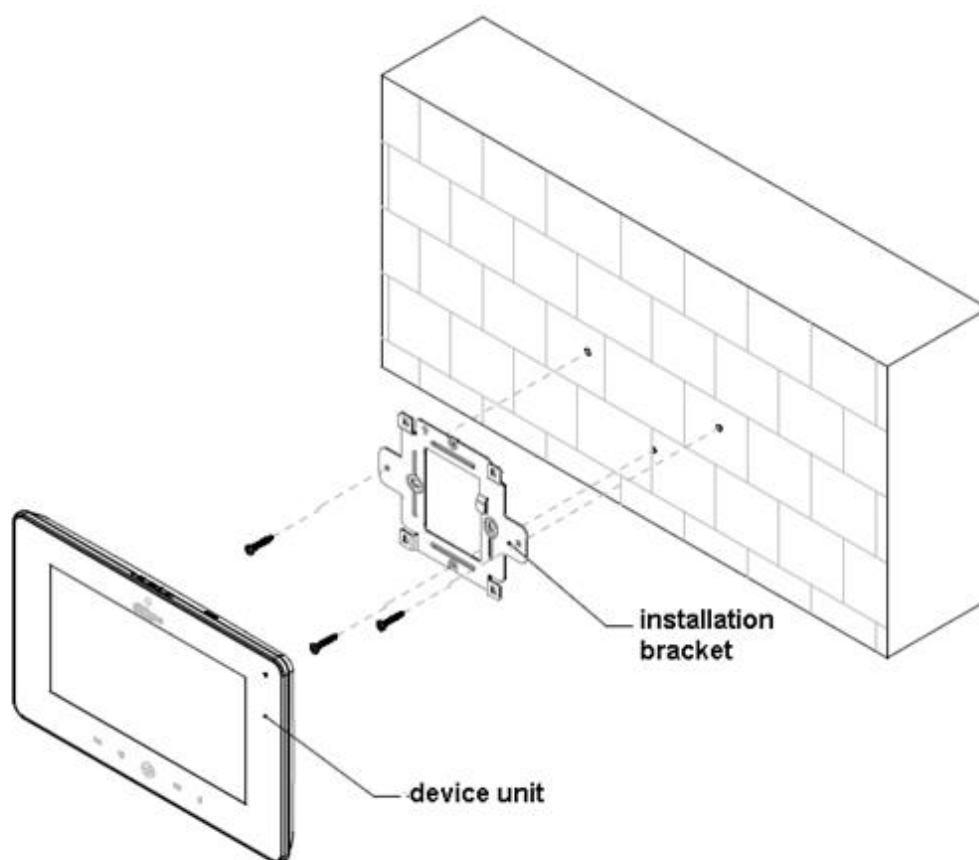

Figure 4-2

Step 1. Embed 86 box into wall.

Step 2. Fix installation bracket on 86 box with two M4×30 cross pan head machine screws.

Step 3. Fix device unit on installation unit with buckle.

Note:

During installation, the recommended distance from device center to ground is 1.4m~1.6m.

4.3 Device Debug

4.3.1 Before Debugging

Debugging personnel shall be familiar with related materials, know device installation, wiring and usage.

Debugging personnel check whether circuit has short circuit or open circuit or not. Make sure circuit is normal, plug device to power.

After debugging end, clear up site (handle plugs, fix device and etc.)

4.3.2 Debug Device

Step 1. Plug device to power.

Step 2. In homepage, long press Settings for 6 seconds. Device pops up Password Verification box.

Step 3. Enter project setup password which is 888888 by default.

Step 4. Press Net Set to connect VTH.

- Wireless:

If the VTH supports WI-FI, you can select wireless connection.

1. Select Wireless, open WLAN, view available WI-FI. See Figure 4-3.

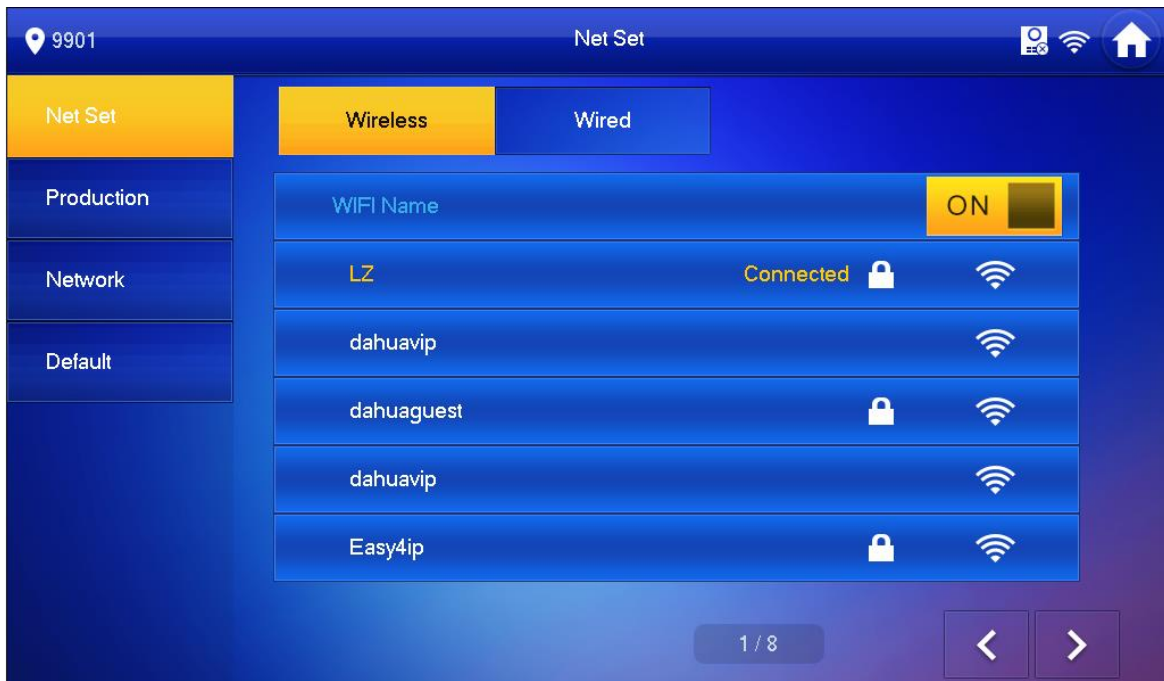



Figure 4-3

2. Select WI-FI you want to connect, and in pop-up WLAN connection window, enter WI-FI password.
3. Press OK.

Now device interface shows  at the upper-right corner which means wireless connection is successful.

- **Wired:**

1. Select Wired. See Figure 4-4.

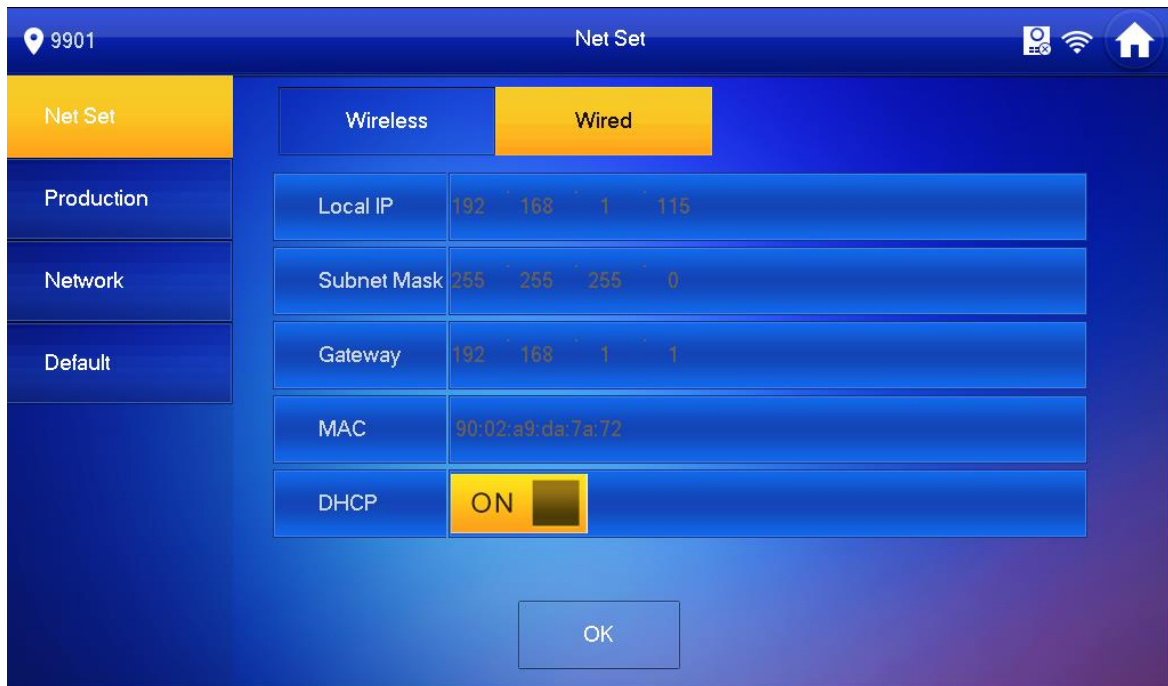



Figure 4-4

2. Enter VTH Local IP, Subnet Mask and Gateway.
3. Press OK.

Now device interface shows  at the upper right corner which means wired connection is successful.

Note:

You also can enable DHCP to auto gain VTH IP, subnet mask and gateway and press OK to complete wired connection.

Step 5. Press Production to config VTH room no.

Warning:

VTH room no. must match VTH short no. on WEB of corresponding VTO.

- If you want to set this VTH to be master VTH, then you shall select Master. Fill in room no., press OK to save, see Figure 4-5.

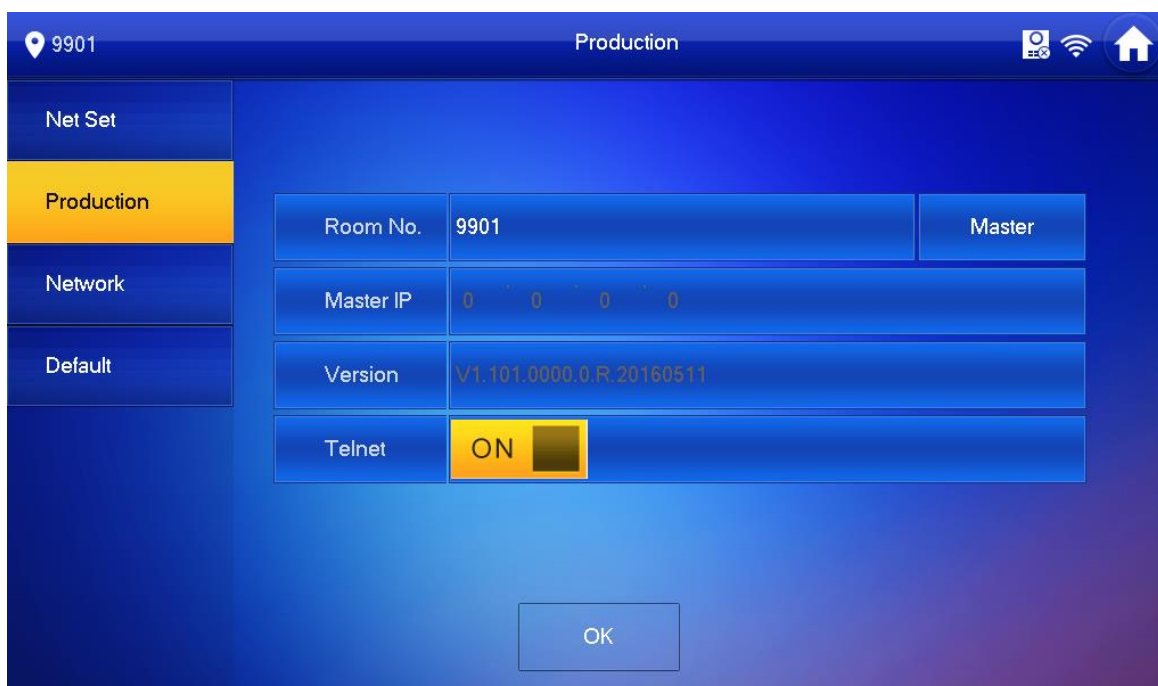

Figure 4-5

- If you want to set this VTH to be extension VTH, then you shall select Extension. Fill in user config info for extension to auto sync with master, such as room no. and master IP. See Figure 4-6.

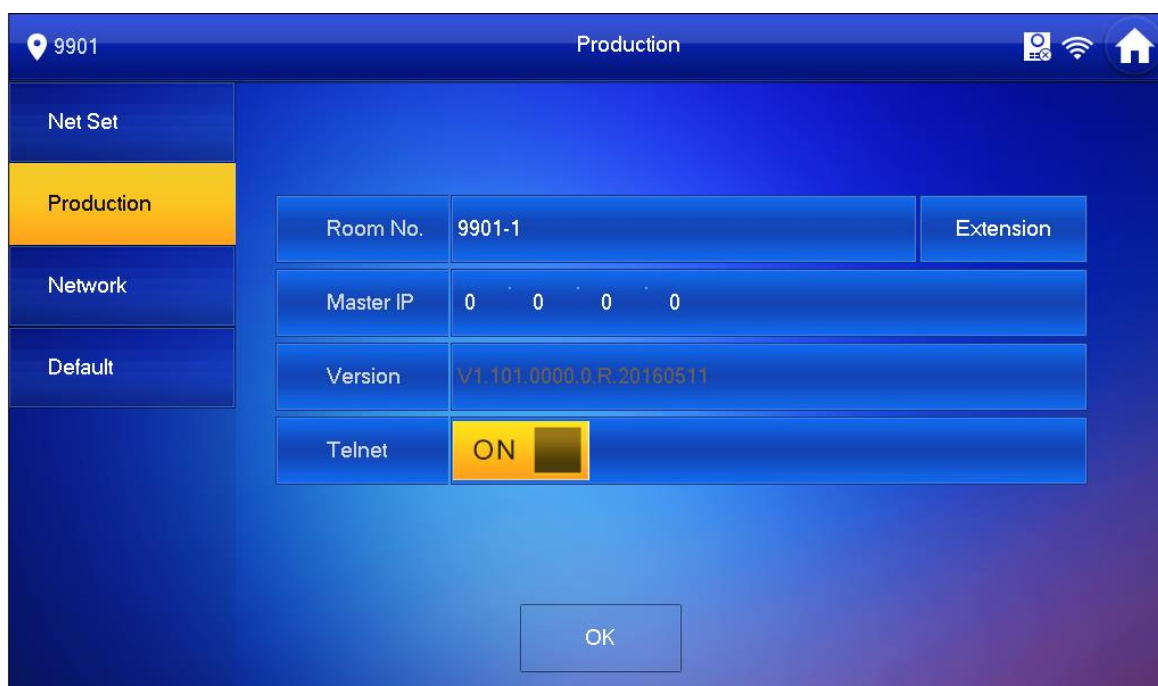

Figure 4-6

4. Press OK to save config. System pops up prompt interface which means config is successful.

Note:

Telnet server is ON, debugging personnel can view VTH config via telnet+IP.

Step 6. Press Network to config VTO info.

Warning:

Before config, please make sure VTO is plugged to power and is in the same segment with VTH.

1. Fill in VTO name, master VTO IP address, set enable status to ON, see Figure 4-7.

The screenshot shows a configuration interface for a device. At the top, there is a status bar with '9901' on the left, 'Network' in the center, and icons for signal strength, Wi-Fi, and a home button on the right. Below this is a navigation menu with four items: 'Net Set', 'Production', 'Network' (highlighted in yellow), and 'Default'. The main area contains two sections for VTO configuration. The first section, 'Main_VTO', has fields for 'Main_VTO Name' (Main VTO), 'VTO IP Address' (192.168.1.100), and 'Enable Status' (ON, with a checked checkbox). The second section, 'Sub_VTO1', has fields for 'Sub_VTO1 Name' (sub VTO), 'VTO IP Address' (192.168.1.132), 'Device Type' (Door, with a dropdown arrow), 'VTO Middle No.' (0), and 'Enable Status' (OFF, with an unchecked checkbox). At the bottom right, there are two navigation buttons: a left arrow and a right arrow.

Figure 4-7

2. Fill in VTO name, and extension VTO IP address, select device type, set enable status to ON.













The device supports n19 units of extensions, and you can press to page down to add more extensions.



4.3.3 Successfully Debug

On VTO dial VTO room no. to call VTH. VTH pops up monitoring video and operation buttons, see Figure 4-8.



Figure 4-8

Icon	Icon Name	Note
	Unlock 1	VTO config electric control lock, press  , unlock.
	Unlock 2	If this VTO has 485 expansion interface, it can expand electric control lock or door sensor lock, after successfully matching with VTH, press  , unlock.
	MIC	Press  , turn off MIC volume.
	IP Camera	Press  , select IPC video of monitoring favorites.
	Snapshot	Press  , to snapshot. Note: When SD card is not installed, this button is grey.
	Record	Press  , record; call ends, press  end recording. Records are stored to SD card of this VTH, if full, it overwrites from the earliest record. Note: When SD card is not installed, this button is grey.

Icon	Icon Name	Note
	Volume	Adjust call volume.
	Accept Call	-
	Hang up	-

5 Product Function

5.1 Homepage

Main menu includes Call, Info, Monitor, SOS, Setting and Arm/Disarm. See Figure 5-1.

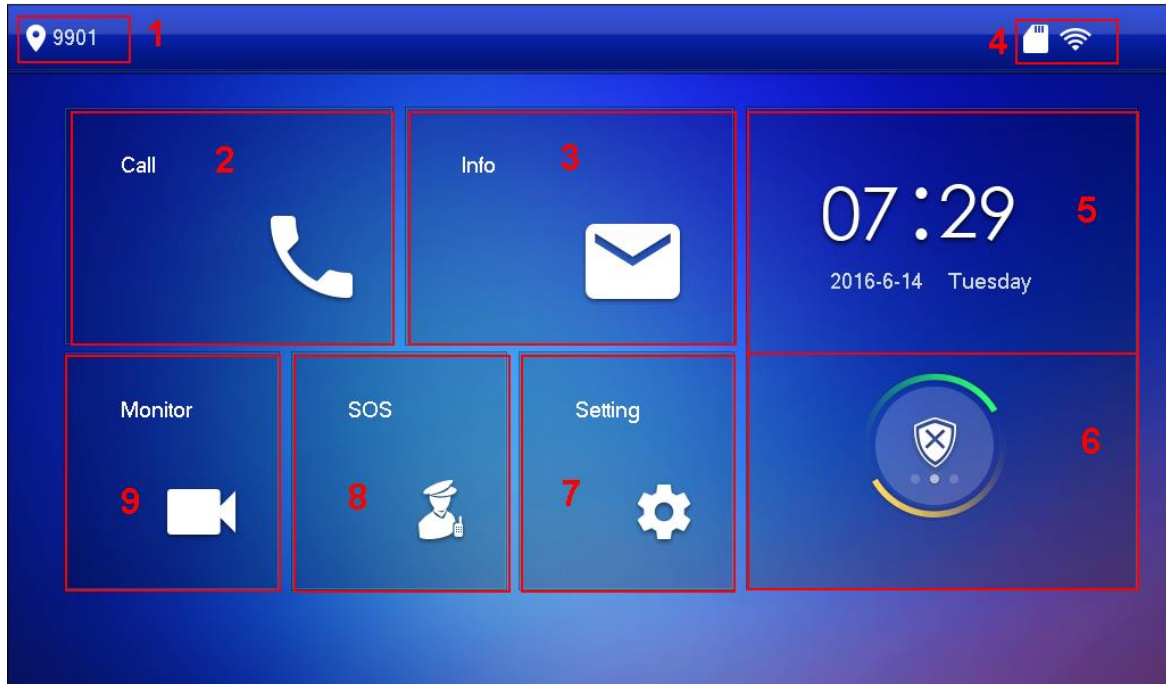









Figure 5-1

No.	Name	Description
1	Room No.	VTH position
2	Call	You can view all call records here, including missed call and outgoing call. You can create contacts.
3	Info	You can view, delete and clear announcement and alarm info released by MGT center, and message and etc.
4	Icon	 : wired network. Device is not connected.  : wired network. Device is connected via wired method.  : WI-FI. Device is connected via wireless method.  : Connect VTO. Device is connected to VTO.  : Not connected to VTO.  : SD card. Device has plugged in SD card. If no this icon, device has not plugged in SD card.

		 : Unread message.
5	Time	Show date, week, time, zone and zone alarm.
6	Arm/Disarm	Press this icon to enter arm/disarm.
7	Setting	Shortly press Setting button, enter setting interface. Long press Setting button for 6 seconds, enter protect setup interface.
8	SOS	Press to call MGT center.
9	Monitor	Monitor VTO, IPC video.

5.2 Setting

You can set interface, set VTH ring, DND, alarm, mode, general and production.

Note:

Initial password to enter Setting is: 123456.

5.2.1 Ring

Go to Setting>Ring, set VTO ring, VTH ring, alarm ring and other.

5.2.1.1 VTO Ring

The device supports up to 19 VTO rings.

Go to Setting>Ring>VTO Ring Setup, select VTO ring, press  or  to adjust.

5.2.1.2 VTH Ring

Go to Setting>Ring>VTH Ring Setup, select VTH ring, press  or  to adjust.

5.2.1.3 Alarm Ring Setup

Go to Setting>Ring>Alarm Ring Setup, select alarm ring, press  or  to adjust.

5.2.1.4 Other

Go to Setting>Ring>Other, see Figure 5-2. Set VTO ring time, VTH ring time, and etc.

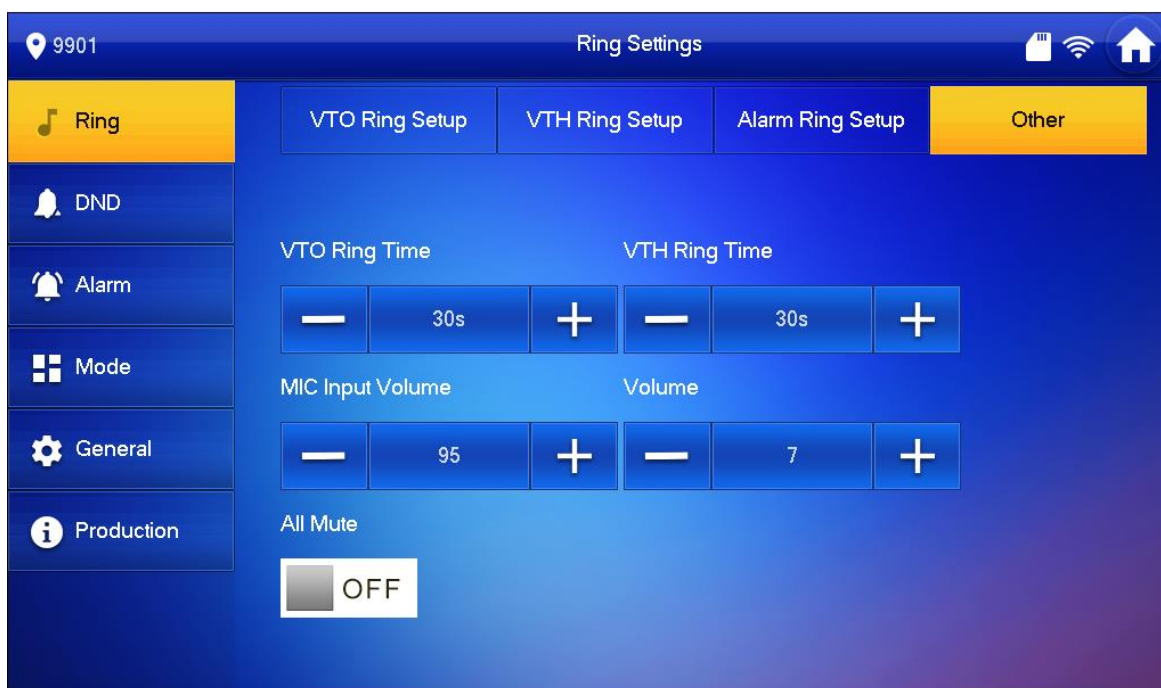

Figure 5-2

Note:

- Ring as VTO calls VTH has maximum of 120 seconds, and message video time is 0-90 seconds. Please refer to Ch 5.2.5.4. If message time is 0 seconds, you cannot leave message.
- When ring time is 15 seconds, if message time is set to 0 second, then VTO calls VTH for 15 seconds and on one accepts, it auto hang up. If message time is not set to 0 second, then VTO calls VTH for 15 seconds and on one accepts, it will ask if you want to leave a message.

5.2.2 DND

During a certain period, if you do not want to be disturbed, you can go to Setting>DND to enable DND function.

By default, DND is not enabled.

There are two types of DND modes, which cannot be enabled at the same time.

- DND hour: within set hours, DND is enabled. 0~24 hours available.
- DND period: within set period, DND is enabled.

5.2.2.1 DND Hour

Step 1. Go to Setting>DND.

Step 2. Press OFF to enable DND hour.

Step 3. Set DND hours.

See Figure 5-3.

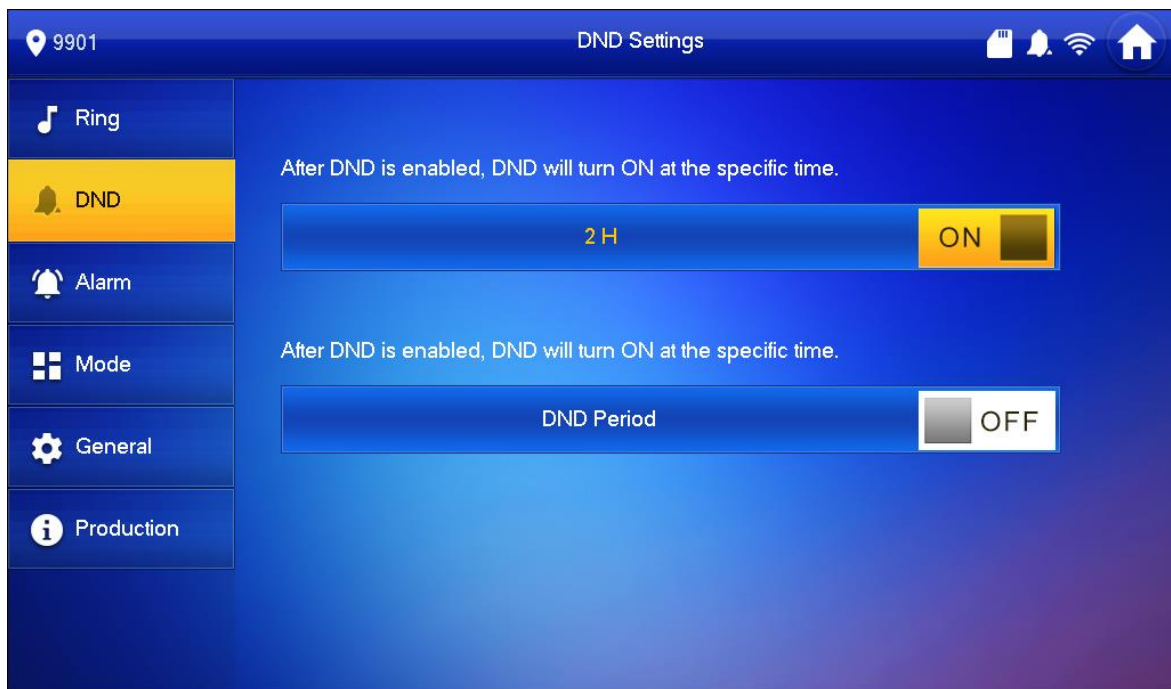

Figure 5-3

5.2.2.2 DND Period

Step 1. GO to Setting>DND.

Step 2. Set period.

Step 3. Set week.

See Figure 5-4.

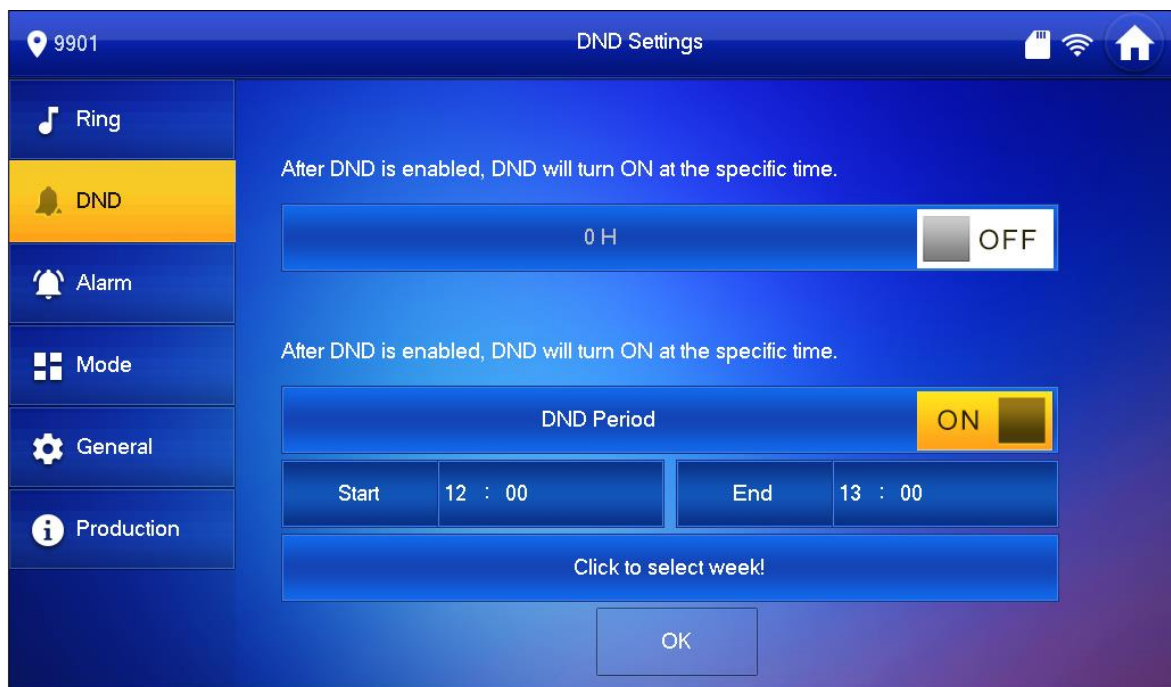

Figure 5-4

5.2.3 Alarm

VTH supports 6-ch alarm zone setup.

Go to Setting>Alarm>Zone, set each zone's alarm switch, alarm status, alarm time and etc.

Step 1. Go to Setting>Alarm. See Figure 5-5.

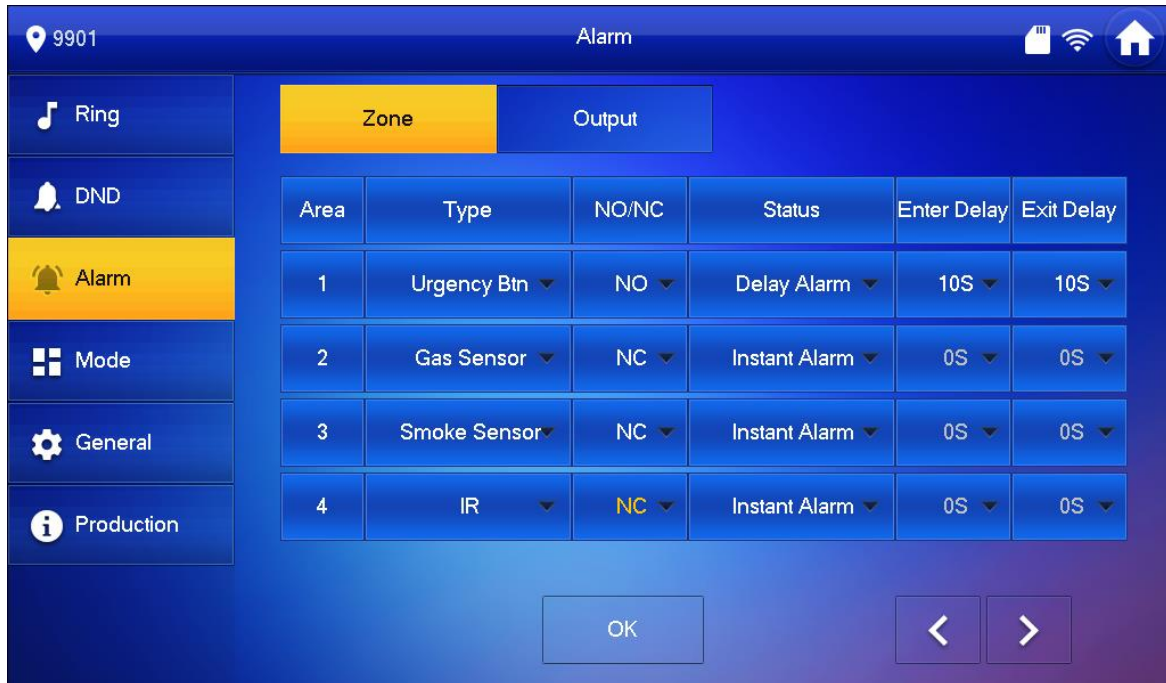

Figure 5-5

Step 2. In Zone interface, follow Chart 5-1 to select zone type, NO/NC, alarm status and delay time.

Parameter	Note
Zone	Set detector zone no.
Type	According to each zone detector type, select zone type, including IR, gas, smoke sensor and etc.
NO/NC	Set detector NO or NC.
Alarm Status	Instant alarm: once prompt tone stops, it enters arming. Delay alarm: it enters arming when delay time ends. Bypass: this zone is shielded during current arming. When disarm, it restore non-bypass status. Remote: This zone is shielded during arming and disarming.
Enter Delay	After disarming is set, it delay by this set time before disarming.
Exit Delay	After arming is set, it delay by this set time before alarming.

Chart 5-1

5.2.4 Mode

Go to Setting/Mode, set switch status of each zone under each mode, including stay, away, sleep and custom. See Figure 5-6.

Note:

You can set zone switch status for each mode in disarming status only.

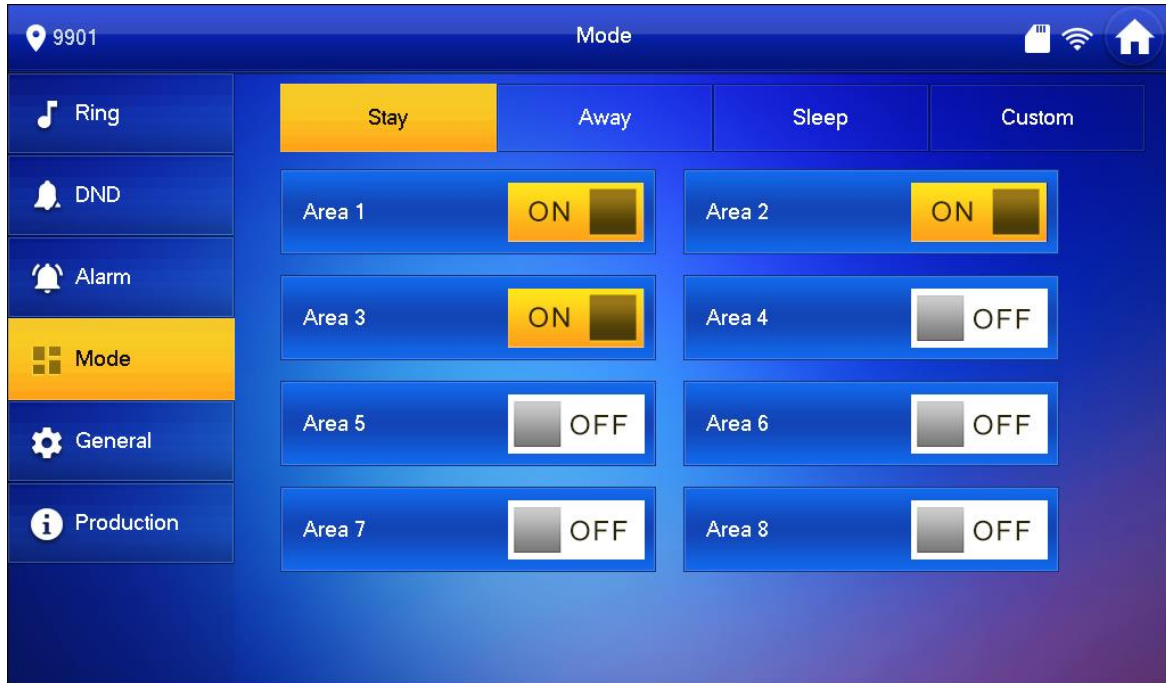

Figure 5-6

5.2.5 General

Go to Setting>General, set VTH time, password, display and etc.

5.2.5.1 Time

Go to Setting>General>Time, set VTH time.

Step 1. Select Setting>General>Time.

Step 2. Press OFF enable system time.

Now device system time and VTO time are synced.

You also may modify system time and set time zone, this time will not be synced with VTO.

See Figure 5-7.

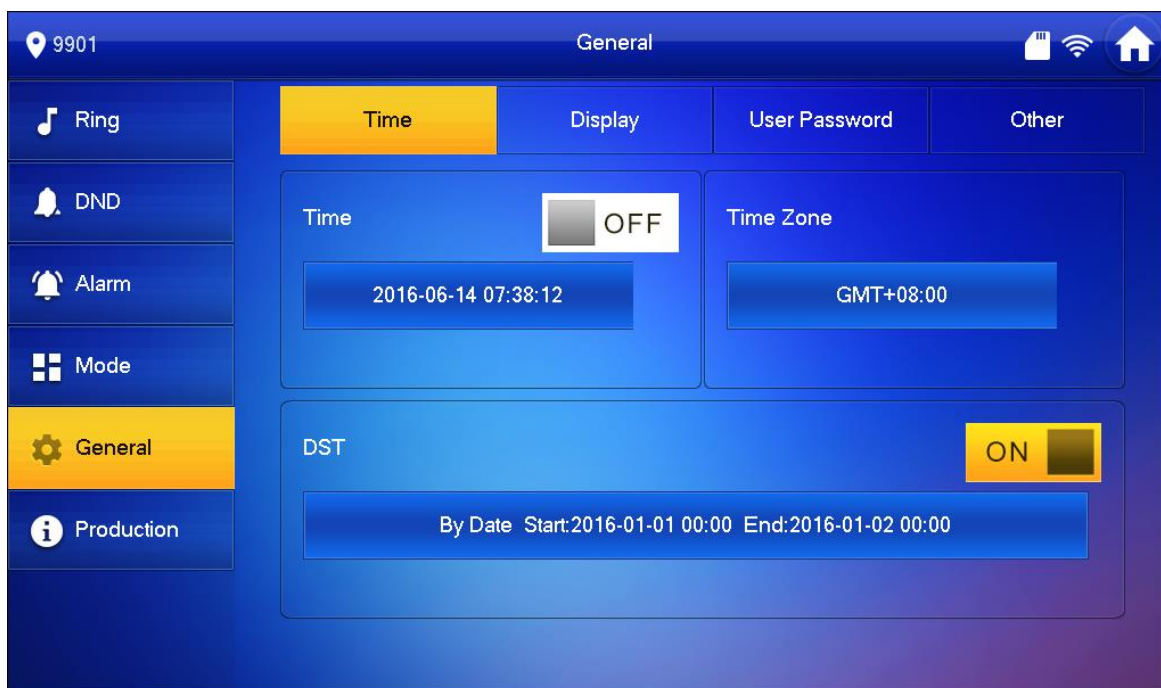



Figure 5-7

5.2.5.2 Display

Go to>Setting>Display, press  or  to adjust screen brightness and screen saver. Press clean to lock screen for 10 seconds and now you can clean up the screen.

5.2.5.3 Password

Go to Setting>General>Password, you can modify setting page password , personal unlock password and arm/disarm password.

Note:

- **Initial password to enter setting interface, and personal unlock password and arm/disarm password are all: 123456.**
- **Duress password is the inverse of arm/.disarm password, for example if arm/disarm password is 123456, then duress password is 654321.**
- **Personal unlock password is used to unlock VTO, as you enter “#+4-digit room no.+ personal unlock password+#”.**

Step 1. Go to Setting>General>Password.

Step 2. Enter old password, new password and confirm new password once. See Figure 5-8.

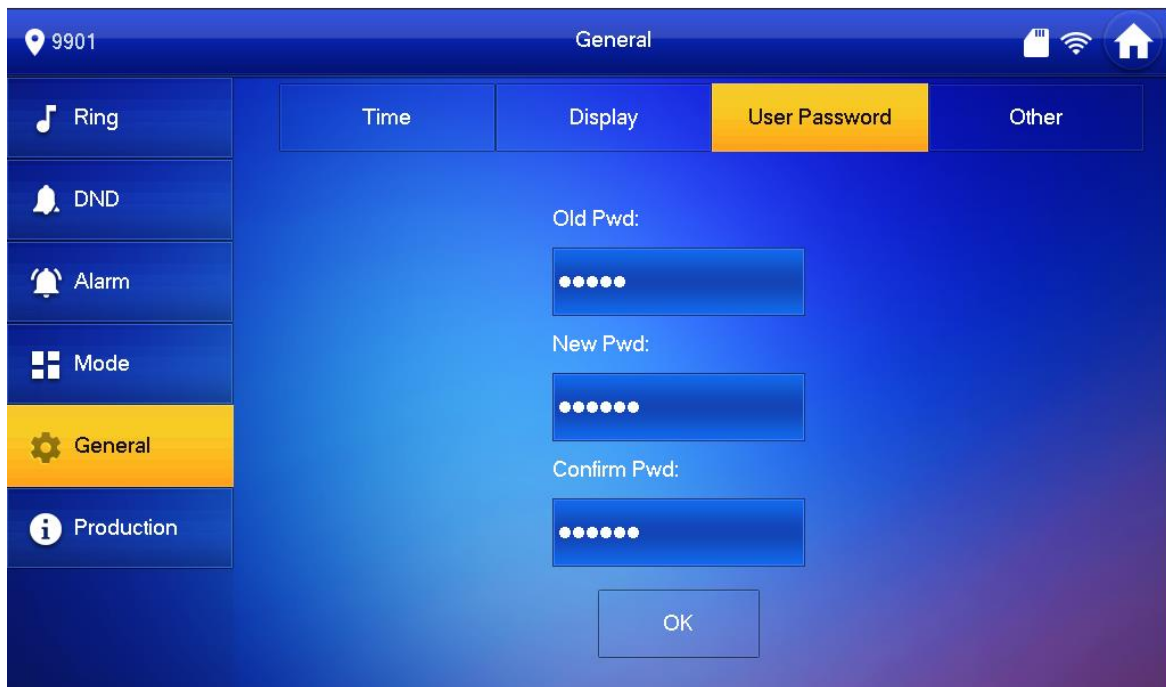





Figure 5-8

Step 3. Press OK.

5.2.5.4 Other

Go to Setting>General>Other. Press  or  to adjust monitor time, record time, VTO message time and VTO call time, inter-resident call time. Press , to enable inter-resident call, touch tone and etc.

Note:

- **If message time is set to 0, than you cannot leave a message.**
- **After enable auto snapshot function, when VTH is being called, it auto snapshots three pictures and save to SD card.**

5.2.6 Production

Go to Setting>Production, see Figure 5-9.

Press reboot System or SD Format to reboot system or format SD card, respectively.

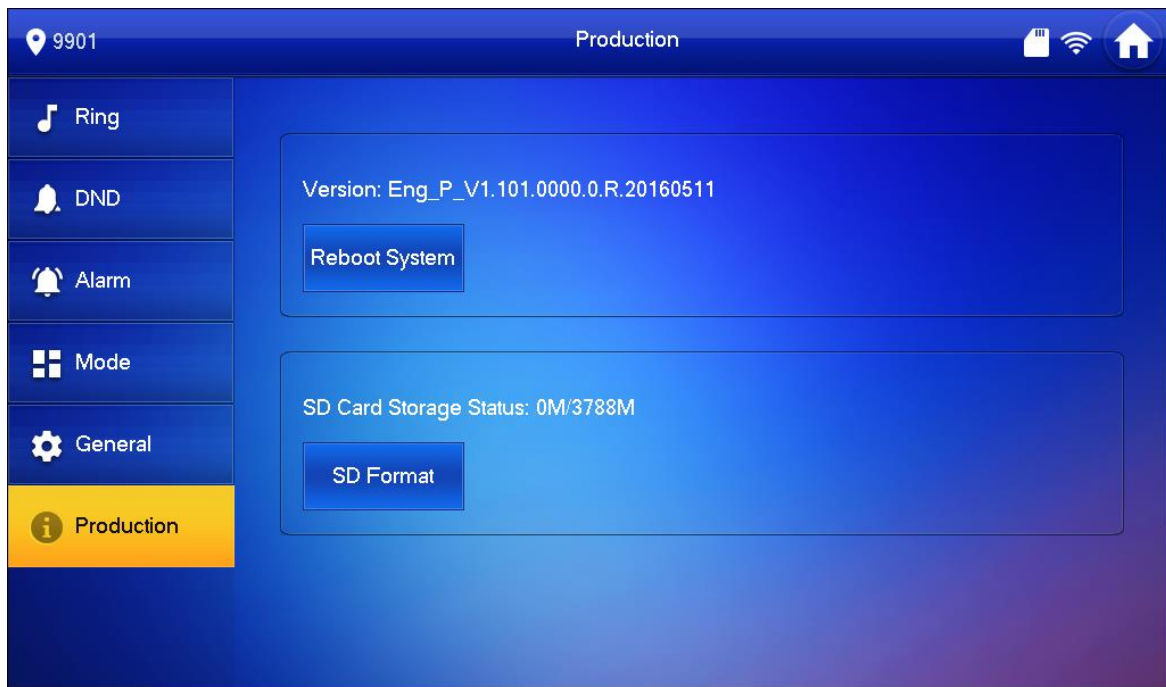

Figure 5-9

5.3 Call

Note:

- Call function is used in VTH calling VTH.
- If two residential VTH both have cameras, then a bidirectional video talk can be performed.

5.3.1 Call Resident

There are two methods to call resident: call user and contact.

5.3.1.1 Call User

Step 1. Select Call>Call User, see Figure 5-10.

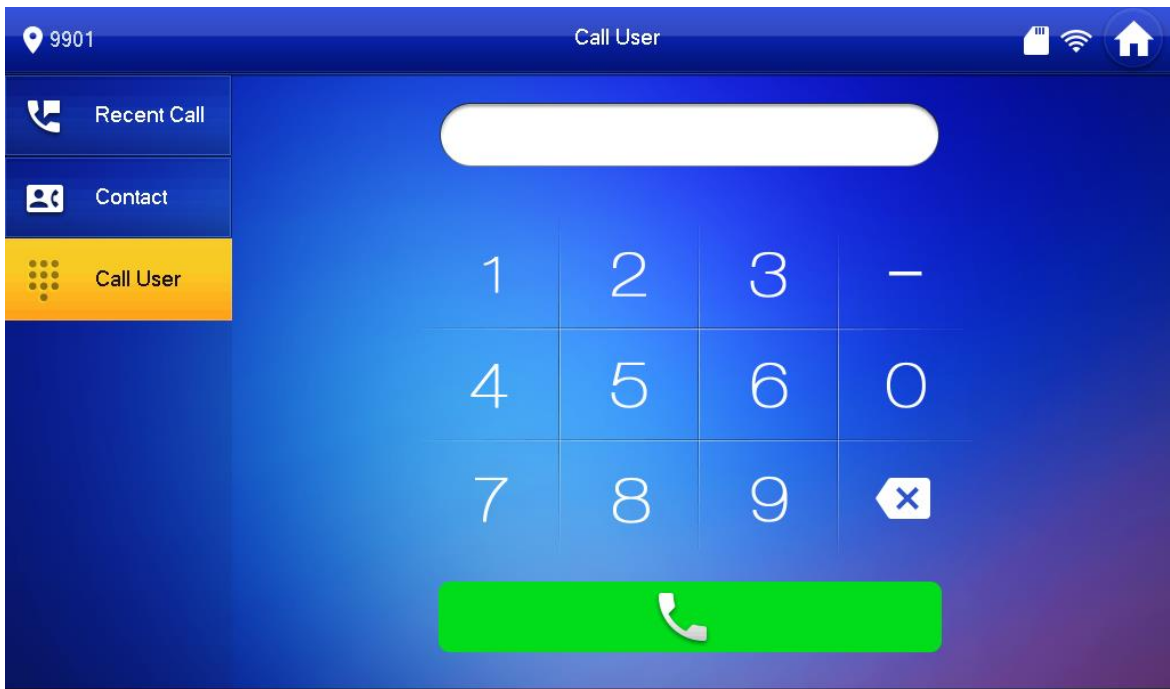



Figure 5-10

Step 2. Enter room no. you want to call, press  icon to call. After call is accepted, you can perform a bidirectional talk.

See Figure 5-11.

Tips:

If you want to call extension of the VTH , such as 9901-1, just enter “-1” to call it.

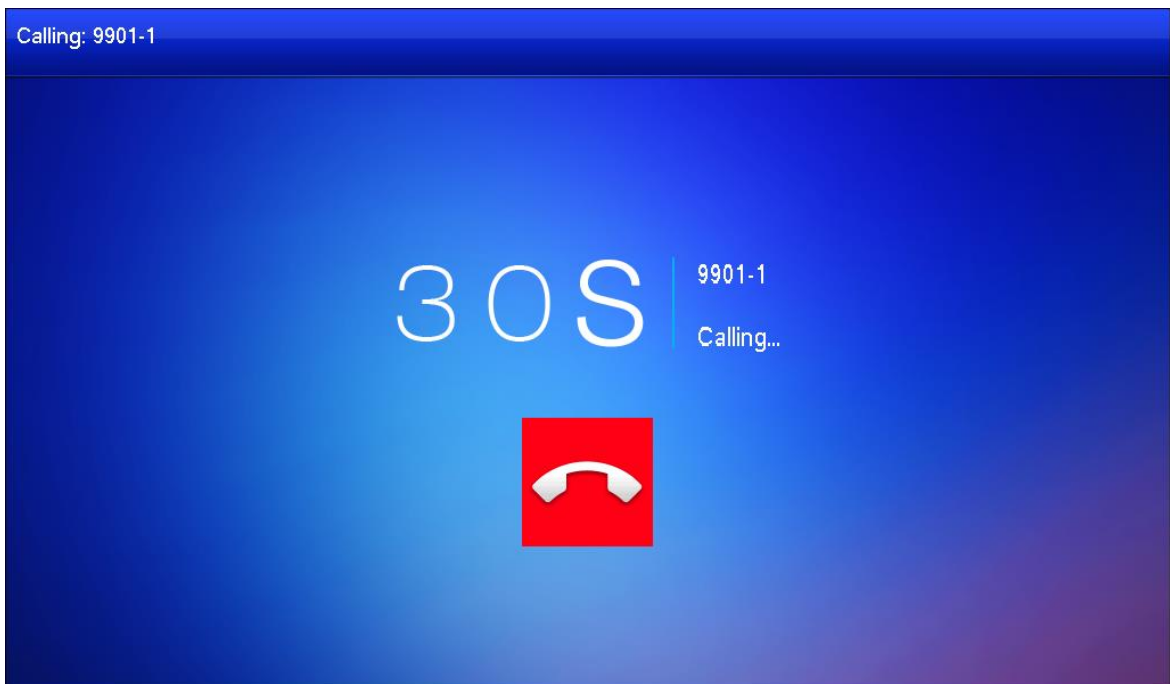



Figure 5-11

5.3.1.2 Call via Contact

Warning:

You must add contact first before you can call designated resident via contact. Please refer to Ch 5.3.2.

Step 1. Select Call>Contact.

Step 2. Select resident you want to call, press  to call.

5.3.2 Contact

Go to Call>Contact interface, you can add, delete, modify call contact.

To add contact:

Step 1. Select Call>Contact. See Figure 5-12.

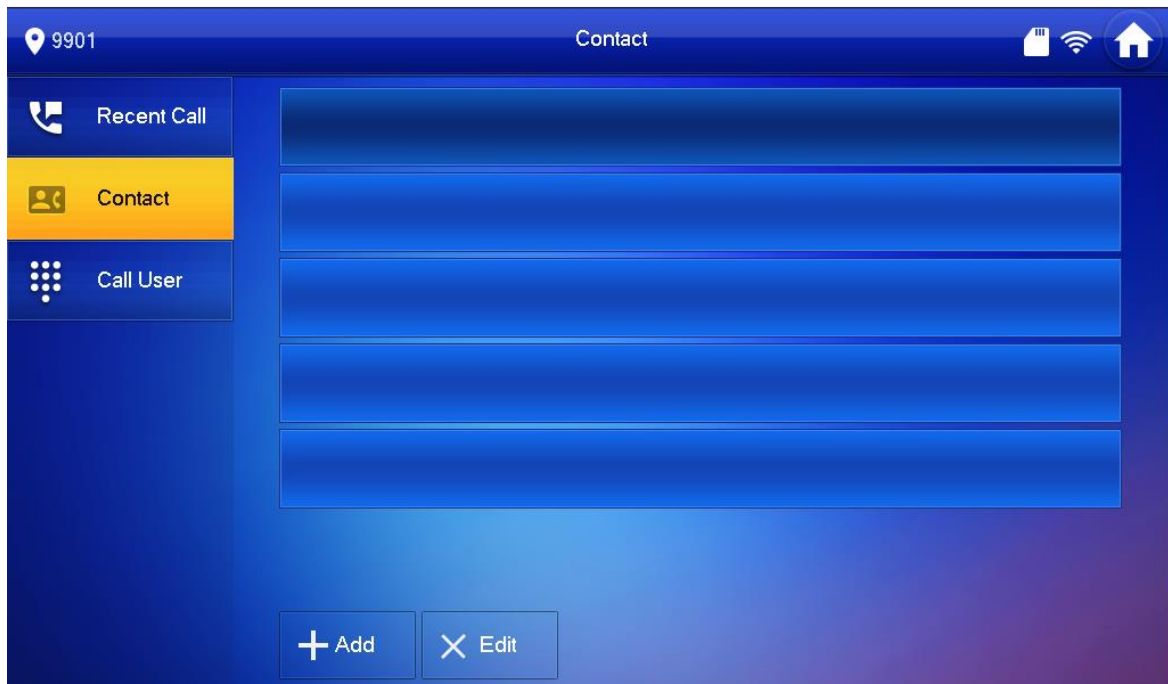

Figure 5-12

Step 2. Press . Device shows User Info page.

Step 3. Enter contact name and room no. See Figure 5-13.

User Info

Last Name

First Name

Room No.

Cancel

OK

Figure 5-13

Step 4. Press OK to add contact.

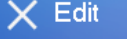
If you want to delete contact, press  and check resident you want to delete, press Delete to delete.

If you want to edit contact, select contact, press  to modify contact.

If you want to call contact, select contact you want to call and press .

5.3.3 Recent Call

In Call>Recent Call interface, you can view, delete call records if the VTH, see Figure 5-14.



Figure 5-14

If you want to call missed call back, just select contact, and press  to call.

If you want to delete call record, press  and select record you want to delete, press

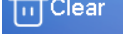
Delete. You also can press  and in pop-up box, press OK if you want to delete all records.

5.4 SOS Call

In case of emergency, press SOS on device or  button in interface to call MGT center.

5.5 Monitor

VTH can monitor VTO or any specific IP camera.

5.5.1 Door

Step 1. Select Monitor>Door. See Figure 5-15.

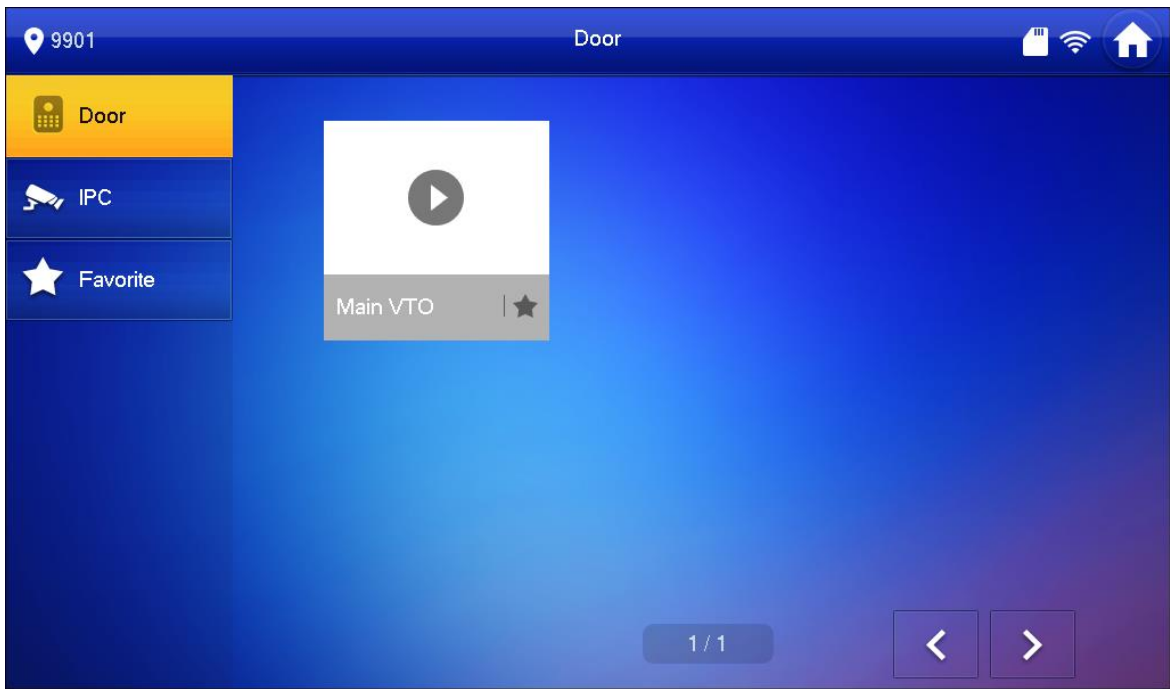

Figure 5-15





Step 2. Select door you want to monitor, press . See Figure 5-16.



Figure 5-16

Step 3. Please refer to Chart 5-2.

Icon	Icon Name	Note
	Return	-
	Snapshot	Press  to snapshot.









Icon	Icon Name	Note
	Record	Press  to record. Save record to SD card, and overwrite if full.
	Unlock 1	VTO with electric control lock, press  to unlock.
	Unlock 2	If the VTO has 485 expansion interface, it can expand electric control lock or door sensor lock, after successfully matching with VTH, press  to unlock.
	Switch	If VTH connects to more than one VTO/IPC, you can press  or  to switch channel.

Chart 5-2

5.5.2 IPC

5.5.2.1 Add IPC

Before monitoring IPC, you must add IPC first.

Note:

- Added IPC in master VTH IPC info interface will be synced to VTH, which cannot be deleted.
- Before you add IPC, please make sure device is plugged to power and is in the same segment with VTH.

Step 1. Select Monitor>IPC.

Step 2. Press Add, see Figure 5-17.

AddIPC_00

Name	<input style="width: 95%;" type="text" value="Ipc00"/>	★
IP	<input style="width: 95%;" type="text" value="0 . 0 . 0 . 0"/>	
User Name	<input style="width: 95%;" type="text" value="admin"/>	
Password	<input style="width: 95%;" type="password" value="●●●●●"/>	
Port	<input style="width: 95%;" type="text" value="554"/>	
Stream	<input style="width: 95%;" type="text" value="Main"/> ▼	
Protocol	<input style="width: 95%;" type="text" value="Local"/> ▼	
Channel	<input style="width: 95%;" type="text" value="0"/>	

Cancel
OK

Figure 5-17

Step 3. Please refer to Chart 5-3.

Parameter	Note
Name	Camera name.
IP	IPC's IP
Username	Username and password to login IPC WEB
Password	
Port	Port no. of IPC
Stream	According to stream type you want to select, when network bandwidth is insufficient, sub stream is recommended.
Protocol	According to IPC supported protocol, select Onvif protocol version and local protocol.
Channel	Select default value.

Chart 5-3

Step 4. Press OK to add camera. See Figure 5-18.

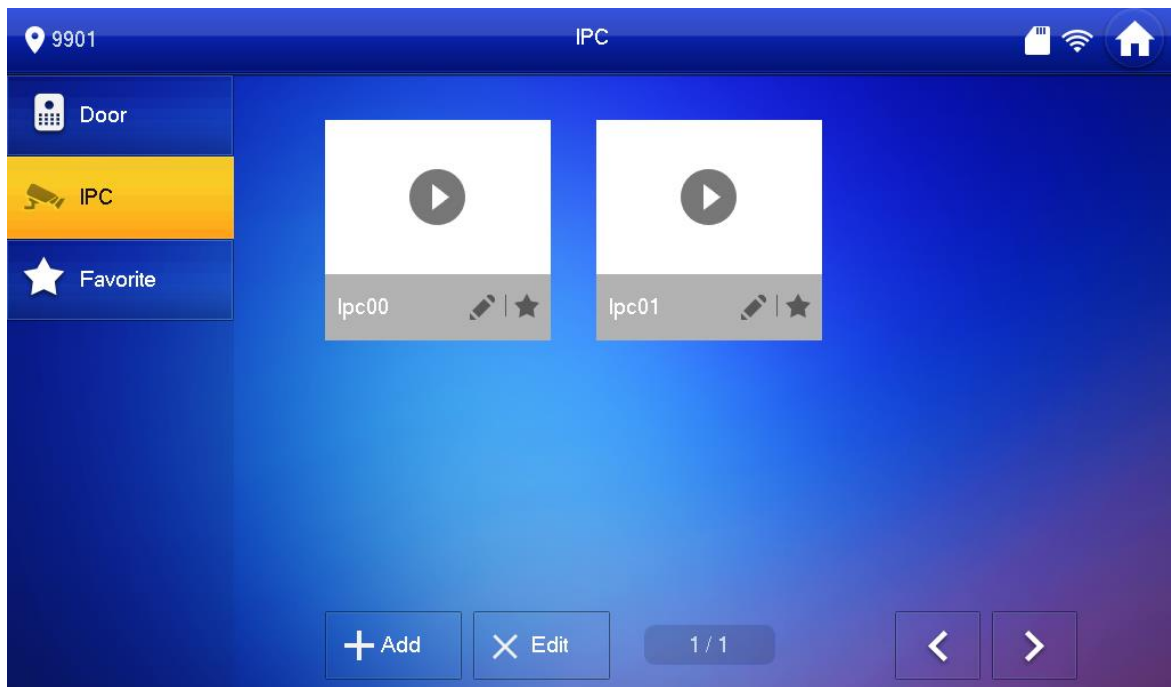

Figure 5-18

If you want to delete IPC, press Edit, and select IPC you want to delete, press Delete.

5.5.2.2 Monitor IPC

Step 1. Select Monitor>IPC.

Step 2. Select IPC to monitor.

Step 3. Press . See Figure 5-19.

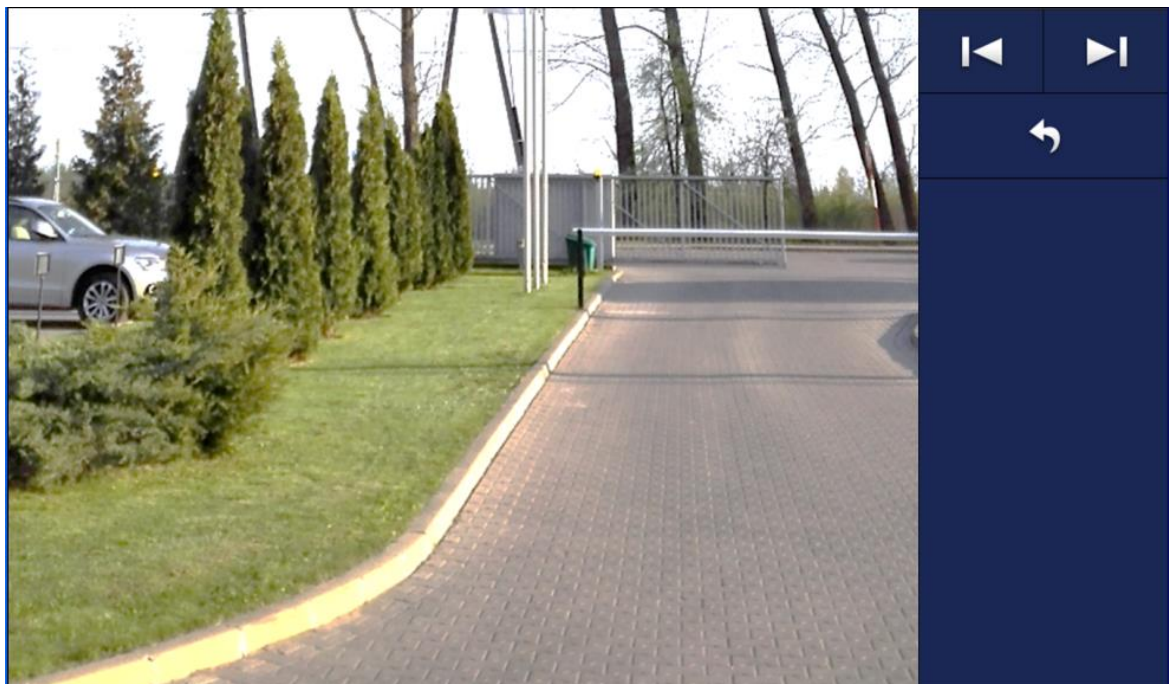



Figure 5-19

Step 4. Please refer to Chart 5-3 and complete operation.

5.5.3 Favorite

If one VTH monitors more than one VTO or IPC at the same time, you can go to Door or IPC interface, select the VTO or IPC you monitor the most frequently, and press  to add them into Favorite.

See Figure 5-20. You can go to Monitor>Favorite interface to monitor corresponding VTO and IPC.

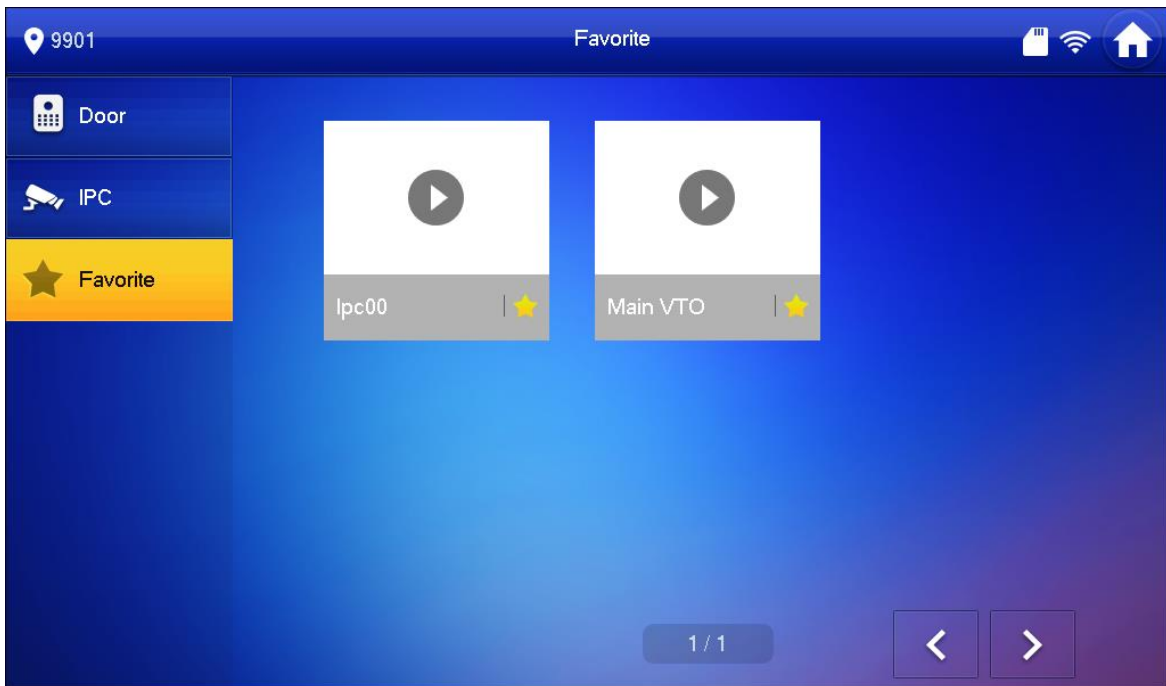

Figure 5-20

5.6 Arm/Disarm

Arm: After arming is enabled, device enters arming status; when alarm is detected, device generates alarm locally and upload alarm.

Disarm: After disarming is enabled, device exits arming status.

Arm



Step 1. In homepage, press . See Figure 5-21.

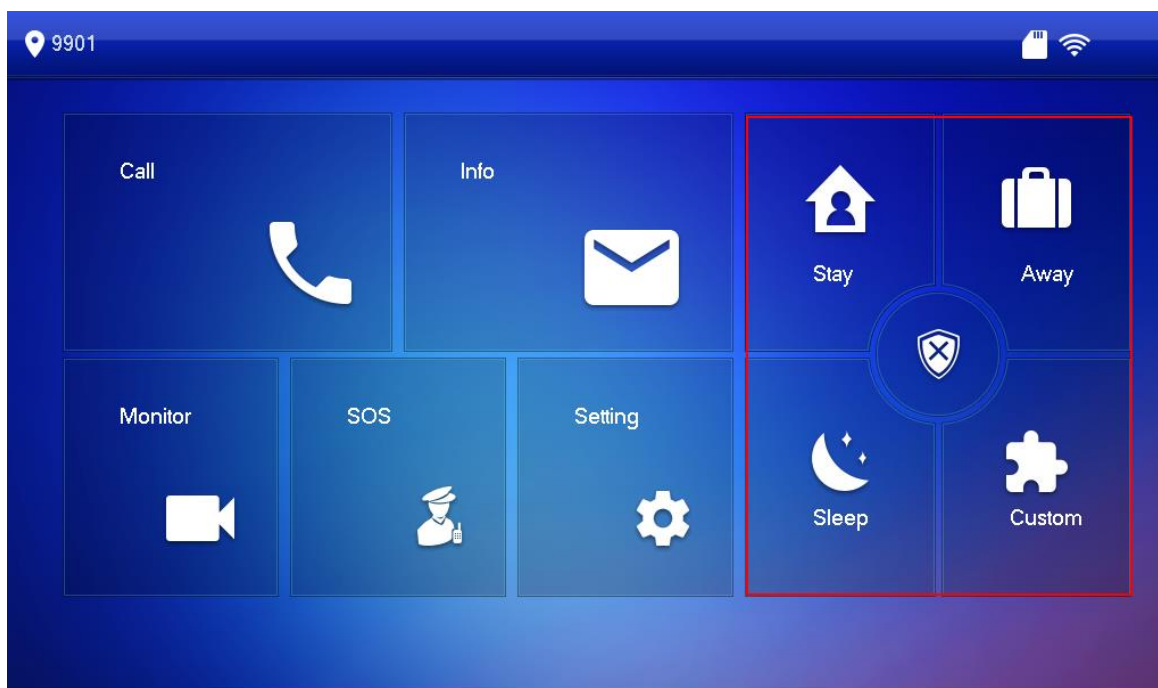

Figure 5-21

Step 2. Select one mode from Stay, Away, Sleep and Custom.

Step 3. In pop-up arm interface, enter arm password.

Device generates tone, which means successfully armed.

Note:

Initial arm password is 123456.

Disarm

Step 1. In homepage, press designated mode to disarm.

Step 2. Press .

Step 3. In pop-up disarm interface, enter disarm password.

If password is correct, it will inform successfully disarmed. If password is wrong, it will ask you to enter password again.

Note:

- Initial disarm password is 123456.
- Please refer to Ch 5.2.5.4 to change arm/disarm password.

Warning:

- In emergency situation, if you are forced to enter disarm password, you can enter duress password, so the system alarm stops working, but the device will auto send alarm to MGT center/platform.
- Default duress password is 654321.

5.7 Info

In home page press , you can view, delete and clear announcement and alarm info released by MGT center, plug guest message and etc. Here used guest message as an example.

Step 1. Go to Info>Guest Message. See Figure 5-22.

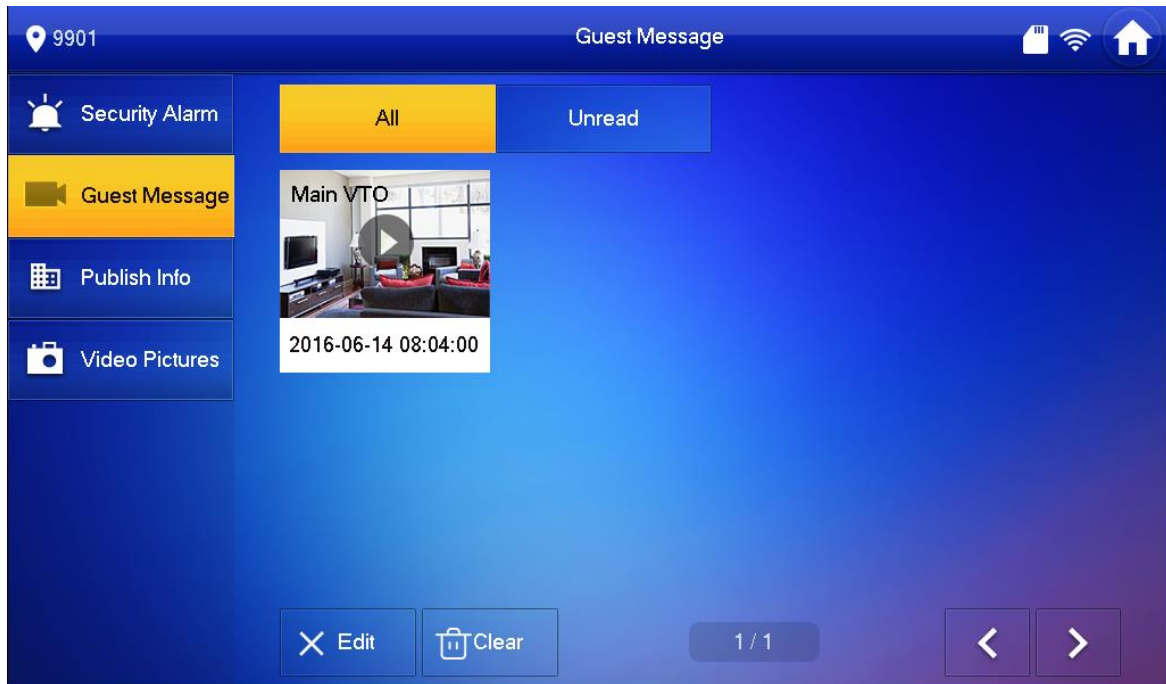



Figure 5-22

Step 2. Select message you want to view, press .

See Figure 5-23.



Figure 5-23

Step 3. Please refer to Chart 5-4.









Icon	Icon Name	Note
	Retune	-
	Switch	Switch to previous/next message.
	Pause	-
	Stop	-
	Quick Play	Quickly play guest message.
	Slow Play	Slowly play quest message.
	Volume	Adjust volume of message.

Chart 5-4

5.8 Default

If you want to restore all settings in project, you can follow these steps:

- Step 1. Long press  for 6 seconds, enter project interface.
- Step 2. Press Default.
- Step 3. In pop-up interface, press OK. Setting in project will be restored to default, and system will reboot.

Appendix 1 Technical Specification

Model		VTH5221D
System	Main Processor	Embedded CPU
	OS	Embedded Linux OS
Video	Display	7 inch HD LCD 1024x600
	Camera(—C model)	1.0 MP CMOS HD camera
Audio	Talk	Bidirectional audio talk
	Input	Omnidirectional MIC
	Audio Enhancement	HLC and NR
Operation Mode	Input	capacitive touch button and 5 shortcut key
	Alarm Input	6-ch
	Alarm Output	1-ch
Structure	Material	PC+ABS
	Installation	Surface mounted
Network	Ethernet	10M/100Mbps self-adaptive ; support WI-FI 802.11b/g/n
	Network Protocol	TCP/IP
General	Power	DC 12V or Standard PoE
	Consumption	Standby≤1W; work≤8W
	Working Temperature	-10~+55℃
	Relative Humidity	10% RH~90%RH
	Dimensions(LxWxH)	215mmx140mmx21mm

Note:

- This manual is for reference only. Slight difference may be found in user interface.
- All the designs and software here are subject to change without prior written notice.
- All trademarks and registered trademarks are the properties of their respective owners.
- If there is any uncertainty or controversy, please refer to the final explanation of us.
- Please visit our website or contact user local service engineer for more information.